

BANG & OLUFSEN

BEOCENTER 2200

Beocenter 2200



Beocenter 2200

User's Guide for
Combined AM/FM receiver,
record player and cassette deck

- 1 Yes, it works
- 2 Where can you place your Beocenter?
- 3 Connecting up
- 4 Setting up the record player
- 5 Switching on
- 6 Switching off
- 7 Playing an FM radio programme
- 8 Playing an AM radio programme
- 9 Playing a record
- 10 Playing a tape
- 11 Adjusting volume
- 12 Adjusting balance, bass and treble
- 13 Presetting FM stations
- 14 Tuning FM stations
- 15 Getting ready to record
- 16 Setting recording level
- 17 Recording a tape
- 18 Recording from an external deck
- 19 Recording from a microphone
- 20 Listening via headphones
- 21 Cleaning tape heads
- 22 Cleaning a record before play
- 23 Cleaning the stylus
- 24 Removing the cartridge
- 25 Tips about record care
- 26 Cleaning the Beocenter
- 27 Trouble-shooting: "What if ...?"
- 28 Glossary of Buttons
- 29 Technical specifications

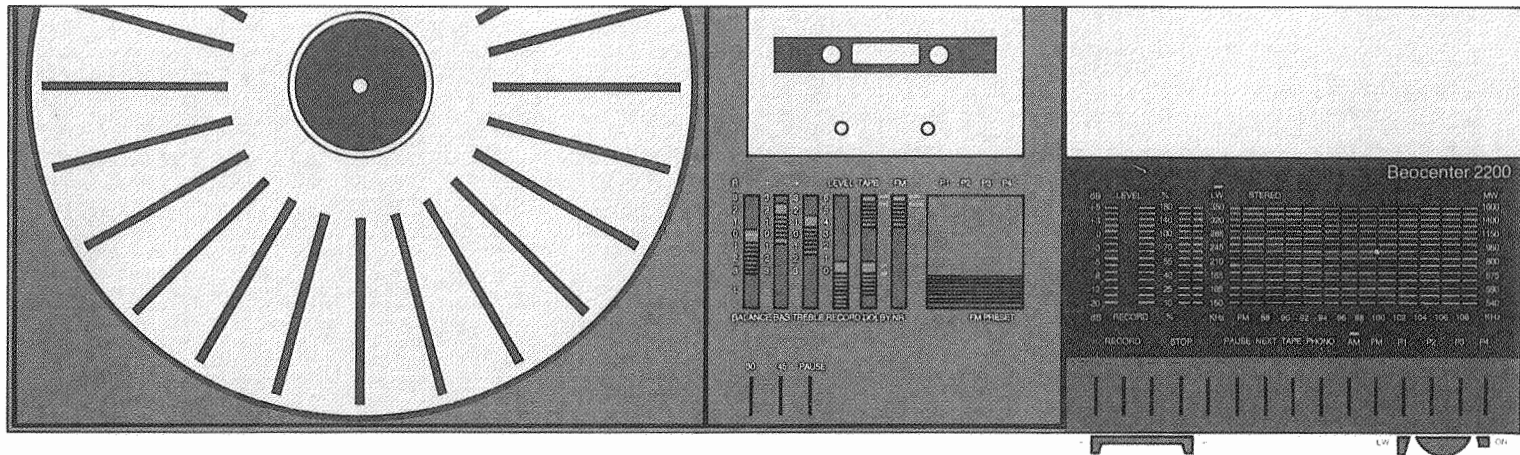

Keep the flap open while you read on

Before you do it your way, try it our way!

Hold the booklet in one hand. Use your index finger to keep the flap open. Alternatively, let the booklet lie open on a flat surface.

In this way you will always see the drawing of the Beocenter's operation buttons and the Guide's table of contents.

Keep these in view as you move through the instructions in the booklet.

The table of contents lists activities you might want to carry out. Numbers next to each activity refer to operating instructions for that activity.

Individual buttons are explained at the back of the booklet. You can also use them as an index to the activities described within.

It's easy to operate the Beocenter. Try it, you'll see.

Important Note

The above drawing and the colour photograph show the Beocenter in its ON mode.

In this mode the set's display panel is illuminated so that you can see:

- a) the names of the primary buttons
- b) frequency scales for tuning radio stations on LW (Long Wave), FM and MW (Medium Wave)
- c) the recording level meter with db and % calibrations.

Note the positions of the red indicator lights: There is one above the AM button, one above the LW scale and a red dot on the 245 kHz frequency line. These indicate that the Beocenter is playing the LW station transmitting on 245 kHz. Of course, this is in the AM band. When the Beocenter is switched off, all the displays disappear.

Secondary buttons are on the left, below the cassette compartment.

1 Yes, it works

The electric lead is permanently connected to the Beocenter. Power requirements: see **29**, Technical specifications.

To verify that your Beocenter 2200 is in good working order, connect the set to the mains power supply.

Press **[ON]**. The Beocenter's display panel will light up. (See **5**, Switching on). To switch off, press **[ON]** again. The displays disappear.

Switch off and disconnect the Beocenter from the mains power supply while you set up the record player and connect up the set. (See **3** and **4**). □

2 Where can you place your Beocenter?

Position your Beocenter wherever it is convenient for you, horizontally on a flat, stable surface. Ensure that the Beocenter is placed well away from sun-filled windows and direct heat from fires and radiators.

Leave at least 5 cms free space at the rear of the set and keep its ventilation slots clear of surfaces that might prevent free circulation of air.

If you place your Beocenter in a shelving system, you will require at least 35 cms free space between shelves in order to open the hinged dust cover freely. The Beocenter is 74 cms wide and 32.5 cms deep.

To prevent disappointment and frustration read and execute the setting up instructions (see **3** and **4**) **before** you place your Beocenter snugly in a shelving system. □

3 Connecting up

Turn the Beocenter so that the rear of the set faces you. (See drawing on this page).

The sockets or connection facilities are placed underneath two panels.

To remove the panels, press the upper slot of each with your thumb and pull forward.

Loudspeakers

Look at the drawing below. Locate the speaker sockets. Loudspeakers in the same room as the Beocenter should be plugged into the appropriate right and left sockets marked SPEAKERS 1.

An extra set of speakers in an adjoining room should be plugged into the sockets marked SPEAKERS 2. They are switched on/off via a button underneath the set's lower front panel. It is marked SPEAKERS 2.

Aerials

Plug the appropriate antenna cables into the sockets marked AM and FM. Consult your authorised dealer about aerial requirement for the area in which you live. If you use an optional indoor FM antenna («rabbit ears» Bang & Olufsen type 8902010) attach the rabbit ears to the special bracket provided. >

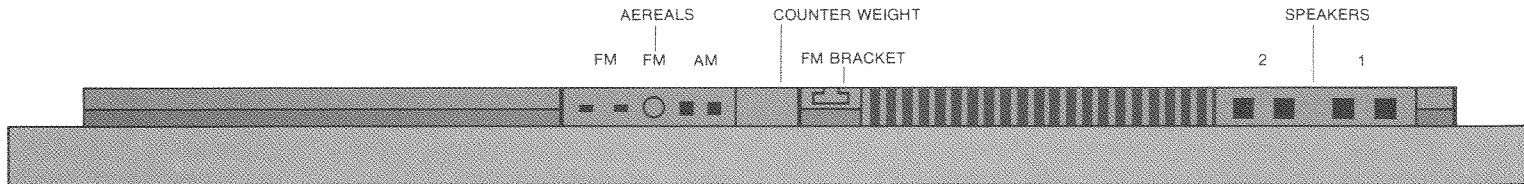
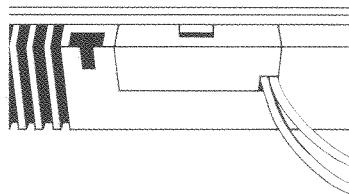
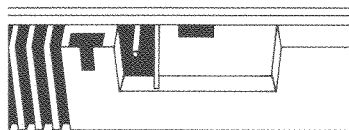

The counterweight

In the space to the left of the AM aerial socket you will see the rear end of the record player's tonearm. This is where the counterweight is to be mounted. It is easier to mount the counterweight if the tonearm is kept stably in place by the white foam material which protected it during transport.

You will find the counterweight in a tiny round cavity in the set's white polystyrene packing material.

Here's how you mount the counterweight: With the counterweight's numerical scale facing you, put the counterweight onto the tonearm and turn it clockwise until the counterweight is screwed home. Do not tighten. Now turn the counterweight anticlockwise, until the figure 1.5 (grams) for the stylus pressure points up. That's it.

If you upgrade to another MMC cartridge (see 24), turn the counterweight anticlockwise until the required stylus pressure figure (1.2 or 1.0) points up.

Replace the panels over the sockets, ensuring that the cables lie flat and exit through the tiny square holes at the lower right hand side of each panel. Turn the Beocenter so that the front faces you.

To set up the rest of the record player, see 4.

If you ever need to transport your Beocenter be sure to remove the counterweight and secure the tonearm in its resting position. □

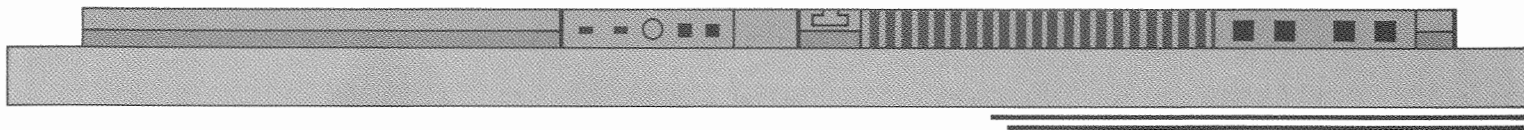
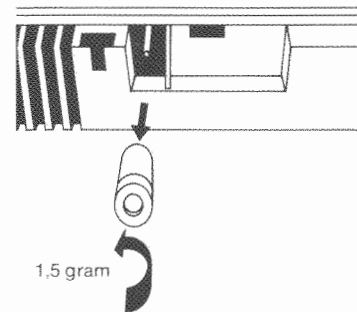
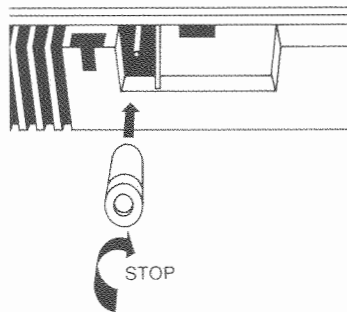

4 Setting up the record player

Disconnect the Beocenter from the mains power supply while you set up the record player.

Mount the counterweight on the tonearm before setting up the rest of the record player. (See 3, Connecting up, The counterweight).

Turn the Beocenter so the front of the set faces you.

Open the dust cover.

Remove the black plastic disc which covers the turntable mechanism. To do this, insert your index finger in the hole provided and pull up.

Three large thumbscrews lock the suspension system of the turntable mechanism, protecting it against vibration damage during transport. These must be unlocked before use.

Notice the illustration of a transport lock shown on the black plastic disc.

Locate the three transport locks. Using your thumb and index finger, turn each screw to the left until it is in its top position. Tighten each screw in the top position.

(If necessary, rotate the metal sub-platter to gain access to the screws).

Replace the black plastic disc.

Put the turntable platter in place.

The pickup cartridge which is fitted to the tonearm has a stylus guard which is usually in the down position during transport. Press this transparent stylus guard up. Remove the red tape which is below the pickup to remind you about the stylus guard.

Remove the packing material from the tonearm. The tonearm might swing out of its resting position. Do not force it back manually. Instead, connect the Beocenter to the mains power supply, and press the **[ON]**-button (See 5, Switching on). The arm will automatically return to its resting position.

To play a record, see 9.

If you ever need to transport your Beocenter make sure the transport screws are locked in their transport positions.

Secure them, using the reverse of the procedures described above. Remember to remove the counterweight and secure the tonearm in its resting position. (See 3). For safe transportation, always transport your Beocenter in its original packing and carton. □

5 Switching on

Connect the Beocenter to the mains power supply.

Press **[ON]**.

You will see illuminated displays on the Beocenter's display panel. (See main drawing).

The Beocenter will automatically start on P1.

This is the first pre-set FM radio station.

A red light appears above the P1 button to indicate this. If the station is being received in stereo, a green light appears above the word **STEREO**.

If the speakers and FM aerial are correctly connected, if you have preset a station on P1 and the volume level is correctly adjusted, you will hear the programme being played on FM radio P1. To play other programmes, see 7-10. To switch off, see 6. □

6 Switching off

Press the **ON** button once again. The Beocenter stops playing and switches off.

All displays disappear.

If you were listening to a record, press **PHONO** once again. This stops play and returns the tonearm to its resting position. To switch off the set, press **ON**. □

7 Playing an FM radio programme

Press **ON** to switch on the Beocenter 2200.

The set automatically starts on P1 which is a pre-set FM radio station. If the P1 button is pre-set to an FM station you will hear the radio programme.

To tune and pre-set FM radio stations see **13** and **14**.

To listen to other pre-set FM radio stations, press the appropriate button: **P2**, **P3** or **P4**.

To revert to P1, press **P1**.

If the programme you are listening to is being transmitted in stereo, a green light will appear above the word **STEREO**.

If you do not want to listen to the programme in stereo, move the FM slider (a secondary function) from AUTO (meaning AUTOMATIC) to MONO. A mono signal will be fed to both loudspeakers. □

8 Playing an AM radio programme

Press **ON** to switch on the Beocenter 2200.

The set automatically starts on the P1 pre-set FM radio station.

To switch to the AM waveband, press the **AM** button. The red light (source indicator) moves from the **P1** button and appears above the **AM** button. At the same time a red light appears above the MW (Medium Waveband) frequency scale.

Tuning MW stations

A thumbwheel placed between the **ON** button and the **LW** switch is used to tune stations in any waveband you select.

To tune and listen to a Medium Wave station, move the thumbwheel in the appropriate direction: left to go down the frequency scale, right to go up. A tiny red "dot" indicates the direction of movement across the frequency scale. You read the frequency number by relating the position of the "dot" to the frequency numbers listed under the MW scale. The MW frequency scale covers from 525 kHz to 1600 kHz.

To tune and listen to other programmes in Medium Wave, move the thumbwheel in the appropriate direction.

Tuning LW stations

You have selected the AM waveband. (See above).

To select Long Wave, press the switch marked **LW**. (It is left of the thumbwheel for tuning).

The red light source indicator moves from the MW scale and appears above the LW scale.

To tune and listen to a Long Wave station, move the thumbwheel in the appropriate direction: left to go down the frequency scale, right to go up. A tiny red "dot" indicates the direction of movement across the frequency scale. You read the frequency number by relating the position of the "dot" to the frequency numbers listed under the LW scale. The LW frequency scale covers from 145 kHz to 350 kHz.

To tune and listen to other programmes in Long Wave, move the thumbwheel in the appropriate direction. □

9 Playing a record

Put the record on the turntable platter.

Press the **[ON]** button to switch on the Beocenter.

The set automatically starts on the P1 pre-set FM station.

To switch to the record player, press **[PHONO]**.

The red light source indicator moves from the **[P1]** button and appears above the **[PHONO]** button.

The record player automatically registers the size of the record, determines the speed at which it is to be played, starts rotating, moves the tonearm to the lead-in groove and lowers the stylus in that groove.

Within seconds you will hear music from the first track.

To stop play, press **[PHONO]** once again.

The pickup arm lifts itself off the record and returns to its resting position. The platter stops rotating.

To resume play, press the **[PHONO]** button.

Selecting another programme source also stops the record player, for example, if you press **[P1]**.

To make a pause during play, press **[PAUSE]** (secondary function). The pickup arm lifts itself off the record and hovers above the track. The record continues rotating.

To listen to another track, move the pickup arm to the track required.

To resume play, press **[PAUSE]** again. The pickup arm lowers onto the track and play continues.

On some records where the run-out groove is shorter than usual, at the end of play the pickup arm might not automatically be returned to its resting place. If this happens, select an alternative programme source, for example press **[P1]**. The arm will return to its resting position and the turntable will stop rotating.

45 or 33 rpm

To play a maxi-single, that is a record which is LP-sized but which requires 45 rpm: put the record on the platter. Press the **[PHONO]** button, then **[45]**.

To play a single which requires 33 rpm: put the record on the platter. Press the **[PHONO]** button, then **[33]**.

Large centre hole

If your record has an **ordinary centre hole**, the Beocenter's centre adaptor will be pressed down automatically as soon as you put a record on the platter. If your record has a **large centre hole**, the Beocenter's centre adaptor will remain up to accommodate it. □

10 Playing a tape

Open the dust cover.

If the cassette you are about to play was recorded with Dolby* noise reduction move the **DOLBY NR** slider (see secondary buttons) to **ON** for best results.

Insert the cassette tape. To do this: hold the cassette so that the tape faces you.

Push the cassette well back into the rear of the compartment and push it down until you hear a »click«.

Press **[ON]** to switch on the Beo-center.

The set automatically starts on the P1 pre-set FM station.

To play the tape, press **[>]** (play).

A red light appears above the **[>]** button and the **[TAPE]** button.

Within seconds you will hear the music.

During playback, green and red LEDs (Light Emitting Diodes) on the set's Peak Programme Meter indicate the signal level of the programme being played.

To play the next track of music, press **[>]** and **[NEXT]**. The deck automatically fast forwards the tape to the next pause or space between two tracks and starts playing from there. During this automatic search mode a red light appears above the **[NEXT]** button.

To stop play, press **[STOP]**. The tape stops instantly and the red lights above the **[>]** and **[TAPE]** buttons disappear.

Selecting another programme source also stops the tape, for example, if you press **[PHONO]**.

To rewind the tape, press **[<<]**. A red light appears above the **[<<]** button.

To stop rewinding, press **[STOP]**. The tape stops instantly and the red light above the **[<<]** button disappears.

To fast forward the tape, press **[>>]**.

A red light appears above the **[>>]** button.

To stop fast forwarding, press **[STOP]**. The tape stops instantly and the red light above the **[>>]** button disappears.

At the end of tape transport (in any mode: **[>]** **[>>]** **[<<]**), the tape will stop automatically.

You can also switch directly between **[>]** play, **[>>]** fast forward, and **[<<]** rewind, without damaging the tape or the cassette deck.

To remove the cassette: when tape transport has stopped, lift the cassette out of its compartment.

There is no "eject" button. □

* Trademark of Dolby Laboratories Licensing Corporation.
Noise reduction system manufactured under License from Dolby Laboratories Licensing Corporation.

11 Adjusting volume

The large slider to the left of the primary operation buttons is for adjusting volume levels. Notice the + and - signs.

Play a programme. (See 7-10).

To increase volume, move the slider to the right (+) until you hear the effect you require.

To reduce volume, move the slider to the left (-) until you hear the effect you require. □

12 Adjusting balance, bass and treble

Press **[ON]** to switch on the Beocenter.

Play a programme. (See 7-10).

Open the dust cover.

The separate sliders for adjusting balance, bass and treble are placed among the secondary buttons on the far left of the panel.

Balance

To adjust the balance between right and left speakers move the **BALANCE** slider in the appropriate direction.

For more sound in the right speaker, move the slider up towards R (for Right). When the slider is at the top of the scale (R 3), all sound will come from the right speaker.

For more sound in the left speaker, move the **BALANCE** slider down towards L (for Left).

When the red line on the **BALANCE** slider is next to the 0 position on the scale, equal amount of signal is being fed to the left and the right speakers.

Under ideal conditions, the stereo image being reproduced by right and left speakers will be in balance.

Bass

To increase bass, move the **BASS** slider up towards + (plus) until you hear the effect you require.

To decrease bass, move the **BASS** slider down towards - (minus) until you hear the effect you require.

Treble

To increase treble, move the **TREBLE** slider up towards + (plus) until you hear the effect you require.

To decrease treble, move the **TREBLE** slider down towards - (minus) until you hear the effect you require. □

13 Presetting FM stations

Press the **[ON]** button to switch on the Beocenter.

The set automatically starts on the P1 pre-set FM button. If a station has been pre-set, you will hear the FM programme being received.

Here's how you pre-set an FM station on the **[P1]** button:

Open the dust cover. Look at the secondary buttons.

Locate the slider indicated by **FM AUTO/MONO**. Move the slider to the **MONO** position.

Locate the little panel below which are the words **FM PRESET**. To remove the panel push it forward until there is a cavity under which you can insert your index finger. Pull the panel up and out.

You will see four tiny thumbwheels, the FM frequency scale and four red station indicators. Note which thumbwheels and station indicators correspond to the P1, P2, P3, P4 indications.

To preset an FM station on the P1 button, turn the thumbwheel to the left or right until you hear the station you require. (Turn left to go up the FM frequency scale, right to go down). The red station indicator will mark the station's transmitting frequency. When all stations are tuned, move the **FM AUTO/MONO** slider to the **AUTO** position.

To preset an FM station on the **[P2]** button, look at the primary buttons. Press the **[P2]** button. Now look at the secondary buttons. Turn the P2 thumbwheel to the left or right until you hear the station you require. (Turn left to go up the FM frequency scale, right to go down). The red station indicator will mark the station's transmitting frequency.

To preset an FM station on the P3 and P4 buttons, repeat the above instructions using P3 and P4 buttons respectively. □

14 Tuning FM stations

Press the **[ON]** button to switch on the Beocenter.

The set automatically starts on the P1 pre-set FM button. If this button has been preset to an FM station (see 13), you will hear the radio programme. When the four preset buttons are preset to FM stations all you have to do to play a radio programme is press the appropriate primary button: **[P2]**, **[P3]** or **[P4]**. (See 7).

To switch to manual tuning on the FM waveband, press the **[FM]** button. The red light source indicator moves from the **[P1]** button and appears above the **[FM]** button.

A thumbwheel placed between the **[ON]** button and the **[LW]** switch is used to tune stations in any waveband you select. (See 8).

To tune and listen to an FM station, move the thumbwheel in the appropriate direction: left to go down the frequency scale, right to go up. A tiny red "dot" indicates the direction of movement across the frequency scale. You read frequency numbers by relating the position of the "dot" to the fre-

quency numbers listed in the line above the primary buttons. The FM frequency scale covers from 88 to 108 MHz.

To tune and listen to other FM programmes, move the thumbwheel in the appropriate direction until you hear the station you require and register its frequency number. For best results, the **FM AUTO/MONO** slider (secondary button) should be in its **MONO** position during tuning. (See 13). □

15 Getting ready to record

Insert a suitable cassette

Make sure the "tabs" at the back of the cassette on which you are about to record are still intact. If they've been removed, you won't be able to record on that cassette. Find another. Or cover the "holes" left by the tabs with two pieces of adhesive tape.

Insert the cassette. Here's how: hold the cassette so that the tape faces you. Push the cassette well back into the rear of the compartment and push it down until you hear a "click".

Select tape type

Look at the secondary buttons. Locate the slider indicated by **TAPE**. This is the tape type selector switch.

If the cassette tape you have inserted is ferro-type (also called normal tape) or chromium dioxide type, move the **TAPE** slider to **AUTO** (for automatic).

If you have inserted a Metal Particle tape, move the **TAPE** slider to **MET** (for metal).

The Beocenter will automatically make the necessary adjustments for the type of tape inserted.

The deck is factory adjusted to the following tape types:
Ferro: IEC 1, e.g. Basf LH 1
Chrome: TDK-SA
Metal: IEC IV, e.g. TDK-MA

Activate Dolby noise reduction

Your Beocenter is fitted with Dolby B noise reduction facilities. To make use of these facilities you must activate the circuit before you start recording. Look at the secondary buttons. Locate the slider indicated by **DOLBY NR**. To activate the noise reduction circuit, move the slider to **ON**.

For optimum results, the Dolby noise reduction circuit should be activated when you playback a tape which was recorded with Dolby. □

16 Setting recording level

To set recording level, there must be a suitable cassette in the deck and the deck must be in its recording mode. Here's what you do: Insert a suitable cassette. See **15**. Look at the primary buttons. Press the **[ON]** button to switch on the Beocenter.

The set automatically starts on the P1 pre-set FM station. You can use this as your programme source. (Or play the programme you require, see **7-9** and **18, 19**). Now press the **[RECORD]** button. The set's Peak Programme Meter (PPM) displays the programme's signal levels with continuously flashing lights.

Look at the secondary buttons. Locate the recording level slider and scale indicated by the word **LEVEL** at the upper end of the scale and **RECORD** at the lower. To adjust recording level, move the slider up (more) or down (less).

As you move the slider the PPM will display the level of signal being fed to the tape head for recording.

The green lights indicate that you're OK.

When all the green lights flash, you have enough signal strength for the recording and there is no danger of overloading the tape. (Overloading causes distortion).

The first flashing red light indicates the 0 dB point which is also fine for most recordings. It indicates that you have saturated the tape 100%. If you exceed this point you will overload the tape and cause distortion.

Occasional peaks in music might cause red lights higher up the scale to flash. It is important that these are **occasional** flashes. If they occur frequently or continuously, lower the recording level setting to prevent overloading.

When you are satisfied with the recording level setting, look at the primary buttons. Press and keep your finger on the **[RECORD]** button, then press **[>]**. The set will start recording. (See **17, 18, 19**). □

17 Recording a tape

You can make tape recordings from any programme source: a record, a radio programme, another tape via an external tape deck (see **18**), or a microphone (see **19**).

Before you start to make a recording, remember to:

- insert a suitable cassette
- select automatic or metal type tape
- activate the Dolby noise reduction circuit (see **15**).

Recording a tape on the Beocenter is extremely easy. Here's how: Press the **[ON]** button to switch on the Beocenter.

The set automatically starts on the P1 pre-set FM station. Select the programme you want to record.

For example, press **[PHONO]**. When you hear the music, press **[RECORD]** and set recording level. (See **16**).

When you are satisfied with the recording level setting, look at the secondary buttons. Press **[PAUSE]** and gently move the pickup arm

until it is above the beginning of the first track. (See **10**).

Now press **[PAUSE]** again, then **[RECORD]** and **[>]**.

The set will start recording. Remember to keep your finger on the **[RECORD]** button while you press the play **[>]** button.

To make a pause during recording, press **[PAUSE]** (primary button). Tape transport stops instantly.

To continue recording, press **[PAUSE]** again.

To stop recording, press **[STOP]** (primary button).

To continue recording, press **[RECORD]** and **[>]**.

To remove the cassette: when tape transport has stopped, lift the cassette out of its compartment. There is no "eject" button. □

18 Recording from an external tape deck

Connect the external tape deck to the socket marked TAPE COPY on the Beocenter. This is on the front of the Beocenter, just underneath the secondary buttons.

Press the **ON** button to switch on the Beocenter.

The set automatically starts on the P1 pre-set FM station. Press the **TAPE** button to select tape as source.

Press the play button on the external tape deck. (See separate operation manual). You will hear music from the inserted tape.

Before you start your recording on the Beocenter, remember to:

- insert a suitable cassette
- select automatic or metal type tape
- activate the Dolby noise reduction circuit (see 15)

Press **RECORD** and set recording level. (See 16).

When you are satisfied with the recording level setting, press **RECORD** again and **>**. (Remember to keep your finger on the **RECORD** button while you press the play **>** button).

To make a pause in the recording, press **PAUSE** (primary button).

To continue recording, press **PAUSE** again.

To stop recording, press **STOP**.

To continue recording, press **RECORD** and **>**.

To remove the cassette: when tape transport has stopped, lift the cassette out of its compartment. There is no "eject" button.

Note:

- 1) You can also use the Beocenter as programme source for an external tape deck. Thus you can record a cassette tape, a record or a radio programme from the Beocenter onto an external deck.
- 2) You can make recordings of a record or a radio programme on the Beocenter's cassette deck as well as on the external deck, simultaneously. (See 17 and separate manual for external deck).
- 3) You can copy a tape from the Beocenter's cassette deck onto an external deck. (See 10, Playing a tape and separate user's manual for external deck).

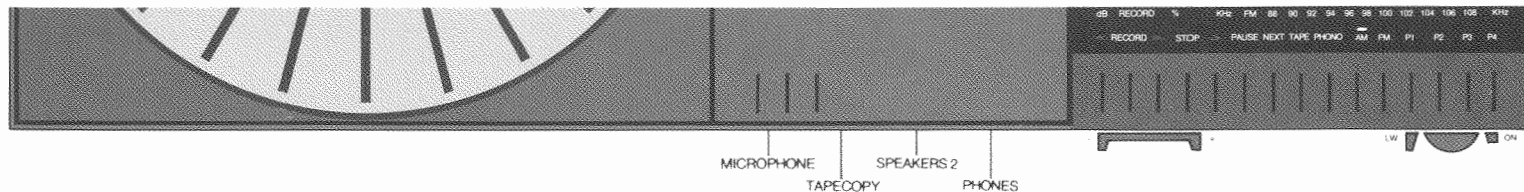

19 Recording from a microphone

Connect the microphone (only mono) in the MICROPHONE socket. This is on the front of the Beocenter, just underneath the secondary buttons.

Before you start recording on the Beocenter, remember to:

- insert a suitable cassette
- select automatic or metal type tape
- activate the Dolby noise reduction circuit (see 15).

Press **RECORD** and set recording level, using a voice sample. (See 16).

When you are satisfied with the recording level setting, press **RECORD** again and **>**. The set will start recording. (Remember to keep your finger on the **RECORD** button while you press the play **>** button).

To make a pause in the recording, press **PAUSE** (primary button). To continue recording, press **PAUSE** again.

To stop recording, press **STOP**. To continue recording, press **RECORD** and **>**.

To remove the cassette: when tape transport has stopped, lift the cassette out of its compartment. There is no "eject" button. □

20 Listening via headphones

Connect the headphones in the socket marked PHONES. This is on the front of the Beocenter, just underneath the secondary buttons.

Sound to the loudspeakers connected in the SPEAKER 1 sockets is muted, as soon as you plug the headphone jack into the socket.

To adjust volume level in the headphones, move the volume control slider to the right (more) or the left (less). □

21 Cleaning tape heads

To continue receiving optimum performance from your deck, the tape heads must be kept clean and free from dust.

Purchase a tape head maintenance kit. They are inexpensive and easy to use. Alternatively, use a cotton wool stick (Q-tip) dipped in a rinsing fluid designed for this purpose.

Gently wipe the tape heads a couple of times.

Do not use denatured alcohol since it may contain ingredients that are hostile to rubber or plastic. □

22 Cleaning a record before play

You should remove dust from the record before play.

Here's how:

Put the record on the platter.

Press **PHONO**, then **PAUSE** (secondary button).

The turntable starts rotating, the tonearm moves to the lead-in groove and hovers above the first track.

You can now clean the record. Use a record cleaner of reputable

23 Cleaning the stylus

Fluff and dust can build up on the tip of the stylus and cause distortion during play. Here's how you should clean the stylus:

Remove the record from the turntable platter.

Locate the tonearm counterweight at the back of the set (see diagram for 4, Setting up the record player).

Gently move the counterweight so the arm swings a **centimetre** or two out of its resting position.

Facing the front of the Beocenter, hold the tonearm firmly with one hand.

brand, in the manner prescribed by the record cleaner manufacturer.

When you have finished using the record cleaner, to resume play press **PAUSE** again.

It is not necessary to put an anti-static mat on the Beocenter's turntable platter since the platter itself provides ample anti-static protection. □

Using the little brush supplied, make three or four gentle sweeping strokes **from the back** of the cartridge towards the front.

Always start from the back, with every stroke. If you brush in any other direction you might cause damage to the cartridge's cantilever and stylus.

Beware of chemical fluids for cleaning records and styli. They can contain solvents which will damage parts of the cartridge. □

24 Removing the cartridge

Locate the tonearm counterweight at the back of the set (see diagram for 4, Setting up the record player).

Gently move the counterweight so the arm swings out of its resting position.

The cartridge is plugged into the tonearm via four tiny pins. The cartridge and tonearm meet just where the black section of the tonearm ends.

You will get a good safe grip if you hold the tonearm on this black section, just where the tonearm bends. Hold the tonearm firmly with one hand.

To protect the stylus move the stylus guard down.

Now hold the cartridge body with the other hand.

Carefully move the cartridge from side to side while you pull outwards.

The cartridge will unplug after a few seconds.

To reconnect the cartridge or plug in a new MMC cartridge, reverse the procedures described above.

Make sure the stylus is pointing down. To protect the stylus make sure the stylus guard is down. When the cartridge is connected, you will hear a little "click". To adjust stylus pressure, see **3**, under "The counterweight".

What about tonearm balance?

The tonearm balance is factory-adjusted for the MMC 5 cartridge. Since all the cartridges in the new lowmass MMC range have identical weight and mass, it is not necessary to adjust tonearm balance even if you upgrade to another MMC cartridge. In this case, just adjust stylus pressure. (See **3**). □

25 Tips about record care

During the design and construction of the Beocenter great care has been taken to include features which ensure minimum record wear and ensure that the record player treats your records gently.

Dust, dirt and static electricity are a record's worst enemies. If you can keep these to a minimum you can also help minimise record wear and thereby prolong the useful lifetime of your records.

Here's how:

Whenever possible, keep the dust cover of the Beocenter 2200 closed. Of course it should also be kept closed whenever the set is not in use.

Always keep your records in their proper covers.

When removing a record from its inner sleeve make sure you do not get fingerprints on the playing surface. And make sure the playing surface is not rubbed excessively against the sleeve. This friction will create a static charge on the record and this will attract dust.

Here's how you should remove the record from the sleeve:

Hold the record sleeve so that its sides bend outwards, away from the record.

Put your hand in under the record, and put your four fingers on the record label. Support the edge of the record with your thumb. Without touching the playing surface, slowly pull the record out of the sleeve.

When putting the record on the platter, hold the rim of the record with both hands. Avoid touching the playing surface. □

26 Cleaning the Beocenter

We recommend Ajax Window Cleaner or its equivalent for cleaning the plastic parts of the Beocenter. Do not use spirits.

The metal parts of the set can be kept clean with a dry cloth. Lower the stylus guard before wiping surfaces close to the stylus.

Grease stains on metal parts can be removed with a lukewarm detergent solution on a soft cloth. Wipe dry with a clean cloth. □

27 Trouble-shooting: "What if..."

This Beocenter music set incorporates a lot of complex technology. It offers numerous functions and features some of which you'll only get to know after you've lived with the music centre for some time.

This is not to say that you have to be an expert to get the best from your music system. Far from it. But there is a chance that the day will come when you press a button and nothing, or the wrong thing, will happen.

Before you call your dealer or pull out your screwdriver, remember that a recent survey shows that over ninety percent of all reported "electronic faults" were not faults at all; but errors in the way users had operated the device or set the controls.

Quite often, it's the simplest problems that are most annoying and frustrating. The "if only I knew how" sort of problems. This simple trouble-shooting section is designed to help you solve some of them. It might also save you an unnecessary service call.

What if my Beocenter automatically starts on P4 instead of P1 sometimes when I switch it on?

The Beocenter will automatically start on P1 everytime you press the **[ON]** button to switch on the set. If it does not, check to see if your hand is accidentally pressing the P4 button at the same time as the ON button. Switch off and try switching on again. Or just press **[P1]**, if that's what you wanted to listen to. (5)

What if my Beocenter shows no sign of life?

Is it connected to the mains power supply?

Is the plug properly connected?
Is the wall socket switched on?

The sign of life to look for: illuminated displays on the set's panel when you press **[ON]**. (2, 5)

What if I want to copy a tape from another cassette deck to my deck on the Beocenter?

Go right ahead. Connect the external cassette deck via the socket marked TAPE COPY on the front of the Beocenter. (18)

What if I can't hear a sound from my Beocenter?

Check the volume control adjustment. Move the slide to the right. (11)

Are the speakers connected properly? (3)

If the speakers are connected to the sockets marked SPEAKERS 2, check the position of the speaker selector switch underneath the front panel. It should be out. Have you plugged in headphones? (This will mute the speakers). (20)

What if I have connected up the Beocenter as instructed and followed instructions about recording a tape, but when I press **[RECORD] nothing happens.**

The recording level meter should display signal levels of the source you want to record and a red light above the **[RECORD]** button should indicate that you want to record. If these don't happen, inspect the cassette tape which you are trying to record on. If the tabs at the back of the cassette have been removed, use a new cassette or cover the "holes" with adhesive tape. (15, 16)

What if my cassettes are recorded with the Dolby noise reduction circuit on, should I also play them back with Dolby on?

Yes. For optimum performance, tapes recorded with Dolby should also be reproduced with Dolby. (15)

Do I have to select tape type for playback as well as recording?

No. The Beocenter will automatically make adjustments for all types of tapes during playback if the tape type switch is on AUTO (automatic).

Before recording you must move the switch to MET (for METal), meaning metal particle tapes) or AUTO (automatic) for all other types of tapes. Beocenter will automatically make adjustments for these types of tapes. (15) □

28 Glossary of Buttons

Primary buttons

ON Switches on the Beocenter. A second push, switches off the Beocenter. (5, 6)

The LW button is at the other end of the ON button (see below). Between the ON and LW buttons you will find the thumbwheel for tuning stations in all wavebands. (8, 14)

P1 to **P4** Each selects a preset FM station. (7)

FM Selects FM as programme source and permits manual tuning of FM stations. (14)

AM Selects AM as programme source and permits manual tuning of stations in Long and Medium Wavebands.

PHONO Starts and stops record player. Plays record automatically. (9)

TAPE Selects an external tape deck as source. (18)

NEXT Plays the next track of music on a tape you are listening to on the Beocenter's tape deck. Searches for a pause between two tracks. (10)

PAUSE Stops tape transport during playback and recording. To resume play, press **PAUSE** again. (10, 16, 17, 18, 19)

> Plays the cassette tape inserted in the Beocenter's tape deck. (10)

STOP Stops tape transport during recording and playback. (10, 16 to 19)

>> Fast forwards the tape.

RECORD Puts the cassette deck in its recording mode. (16) Starts the recording function. (17, 18, 19)

< Rewinds the tape. (10, 17, 18, 19)

LW Selects LW (in) or MW (out) as programme source. Permits tuning of radio stations in LW or MW. (8) The ON button is at the other end of the LW button. Between the LW and ON buttons you will find the thumbwheel for tuning stations in all wavebands. (8, 14)

+ and **-** (The volume control slider). Adjusts volume levels up (+ louder) or down (- softer). (11)

Secondary buttons

FM PRESET: P1, P2, P3, P4 Facilities for presetting four FM radio stations. (13)

FM: AUTO/MONO Slider for switching to mono if you don't want to hear an FM transmission in stereo. In the **AUTO**(matic) mode you will hear stereo programmes.

A green light will appear above the word **STEREO** on the display panel. Automatic Frequency Control (AFC), a circuit which automatically locks tuned FM stations will be activated when the slider is on **FM AUTO**. While you tune stations the slider should be on **FM MONO**. After tuning move the slider to **FM AUTO**. (7, 14)

TAPE: AUTO/MET Slider for selecting tape type. **AUTO**(matic) means normal or ferro-type and chrome tapes. **METal** means metal particle tapes. (15)

DOLBY NR: ON/OFF Switches the Dolby noise reduction circuit on or off. (15, 17, 18, 19)

RECORD/LEVEL Slider for setting the recording level before recording. (16)

TREBLE Adjusts treble: more (+), less (-). (12)

BASS Adjusts bass: more (+), less (-) (12).

BALANCE Adjusts the amount of sound being fed to the right and left stereo speakers. (12)

PAUSE Lifts the pickup off the record while the record continues to rotate. In this mode, you can move the tonearm to another track, to the beginning of the same track or let it hover above the lead-in groove so you can clean the record. (9, 17, 22)

45 Lets you play maxi-singles without fuss. (9)

33 Lets you play singles which require 33 rpm. (9) □

29 Beocenter 2200 Technical Specifications

| | |
|--------------------------------------|-----------------------------------|
| Type No. | 2422-2425 |
| Power output RMS DIN | 2 x 25 watts/4 ohms |
| Harmonic distortion -26 dB | <0.15% |
| Harmonic distortion | <0.2% |
| Intermodulation | <0.4% |
| Frequency range ± 1.5 dB | 20-20,000 Hz |
| FM range | 87.5-108 MHz |
| FM sensitivity stereo 46 dB | <35 μ V/75 ohms |
| AM range LW | 147-350 kHz |
| AM range MW | 520-1610 kHz |
| Pickup | MMC 5 |
| Stylus | Elliptical diamond 6 x 17 μ m |
| Recommended tracking force | 15 mN/1.5 gram |
| Frequency range | 20-20,000 Hz ± 3 dB |
| Wow and flutter, DIN | < $\pm 0.07\%$ |
| Wow and flutter, WRMS | < $\pm 0.035\%$ |
| Rumble weighted | >70 dB |
| Rumble unweighted | >50 dB |
| Noise reduction | Dolby B |
| Tape switch | Aut. ferro/chrom, manual metal |
| Wow and flutter | < $\pm 0.2\%$ |
| Frequency range metal/chrom/ferro | 30-15,000 Hz |
| Signal-to-noise ratio | |
| Metal Dolby NR | >66 dB |
| Chrom Dolby NR | >65 dB |
| Ferro Dolby NR | >63 dB |
| Microphone input | 0.15 mV/2 kohms |
| Power supply | 240 (110-130-220) volts |
| Power frequency | 50-60 Hz |
| Power consumption | 18-135 watts |
| Dimensions W x H x D | 74 x 9.5 x 32.5 cm |

Guarantee

This Beocenter fulfils the conditions stated in the EEC Directive 76/889 concerning radio frequency interference.

International guarantee

This Bang & Olufsen product carries a guarantee against defects in workmanship and materials. It is a national guarantee, extended by Bang & Olufsen in the country in which the product was bought. The terms of the guarantee apply principally to the country of purchase but will be met by authorized Bang & Olufsen dealers in other countries.

For the UK market only.

IMPORTANT

The wires in this mains lead are coloured in accordance with the following code:

Blue: Neutral

Brown: Live

As the colours of the wires in the mains lead of this apparatus may not correspond with the coloured markings identifying the terminals in your plug proceed as follows: The wire which is coloured blue must be connected to the terminal which is marked with the letter N or coloured black. The wire which is coloured brown must be connected to the terminal which is marked with the letter L or coloured red.

Ensure that your equipment is connected correctly. If you are in any doubt, consult a qualified electrician.

Technical specifications subject to change without notice

